

^ 1:1 X-Band LNA Compatible Plate Assembly

Description

At the heart of all Paradise Datacom redundant LNA systems are the field-proven low noise amplifier product lines.

Available in all common X-Band frequencies, and offering state-of-the-art noise temperature performance, these LNAs can be configured for use in 1:1, 1:2 and custom redundant systems.

System monitoring and control is provided through the microprocessor-based RCP2-1100 and RCP2-1200 redundant control panels.

LNA plate assemblies are designed for convenient integration into any antenna hub or facility with RF and user interfaces readily accessible.

Common feed interfaces are offered as standard and isolation is provided at all RF interfaces. A range of RF hardware options and custom plate configurations are offered to meet specific system requirements.

LNA PLATE

- Compact plate assemblies facilitate convenient antenna hub mounting
- Standard feed orientations
- State-of-the-art noise temperatures provided by Paradise Datacom LNAs
- All LNAs contain integral RF isolators

CONTROL PANEL

- User-friendly M&C provided locally as well as through a standard serial I/O. (RS-232, 485 or optional Ethernet interfaces)
- Auto-ranging redundant power supplies: 85-264 VAC @ 47 to 63 Hz
- High system level reliability

OPTIONS

- LNB Redundant Systems
- Transmit-band Reject Filter
- Off-line RF I/O
- Waveguide Test Inject Input Coupler
- Coaxial Output Coupler
- Custom LNA Plate Configurations
- -48 VDC Operation
- Remote Control Panels

RCP2-1100 Front Panel Overview; used with 1:1 Redundant Systems

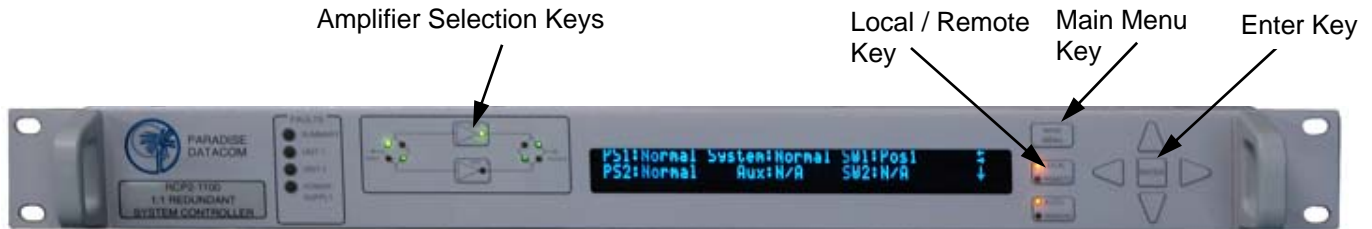

RCP2-1200 Front Panel Overview; used with 1:2 Redundant Systems

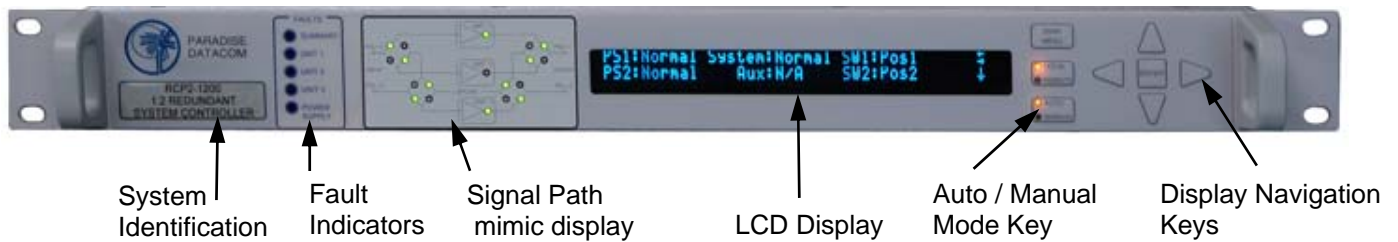

RCP2-1100/1200 Rear Panel



RCP2-1100/1200 General Specifications

Characteristic	Specification
Configurations	RCP2-1100 ; 1:1 Redundant System RCP2-1200; 1:2 Redundant System
Switch Time	Fault Detection, 20 - 50 msec Total Switchover (including mechanical switch) - 100 msec maximum
Switch Drive	26 VDC @ 5 Amps
Alarm Input	Closure to Ground, (Ground=OK / Open=Fault)
Serial Communication	RS232 / RS485 4 wire
Parallel I/O	
Status Outputs	Form C Relay Contacts (10 sets)
Control Inputs	Contact Closure to Ground
AC Input Power	85-265 VAC, 47-63 Hz, 1 A max, > 0.93 power factor
DC Input Power (48 VDC Input Option)	36-72 VDC, Maximum DC Input current @ 48V - 2 Amps



X-Band 1:1 LNA Plate Outline

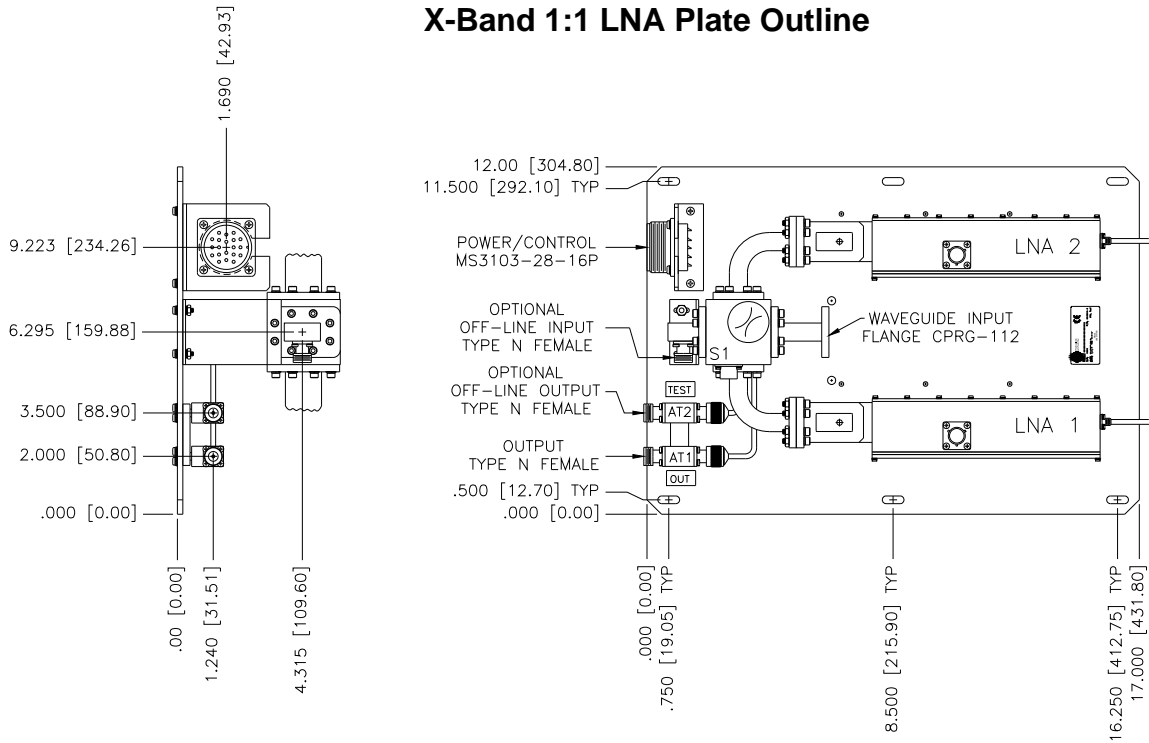

NOTES:

- 1 DIMENSIONS ARE IN INCHES (xxx) ARE IN mm.
- 2 BASE PLATE MOUNTING HOLES ARE CLEARANCE FOR 1/4" SCREW AND PROVIDE .48" TOTAL ADJUSTMENT IN THE "X" PLANE

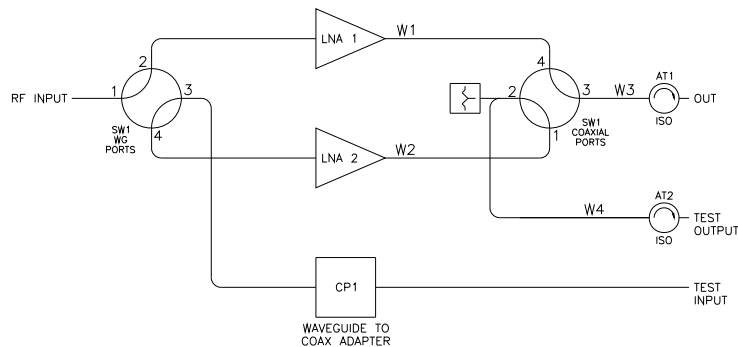
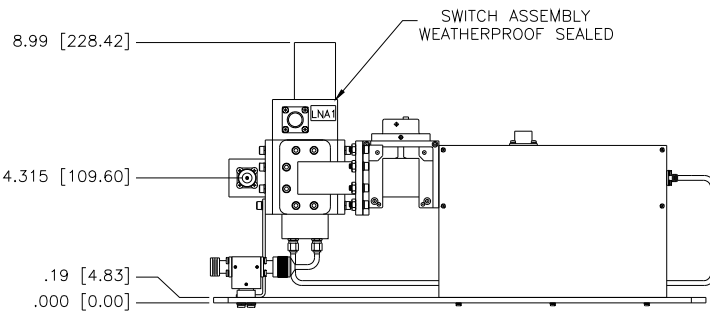



X-Band 1:1 LNA Compatible Plate Outline

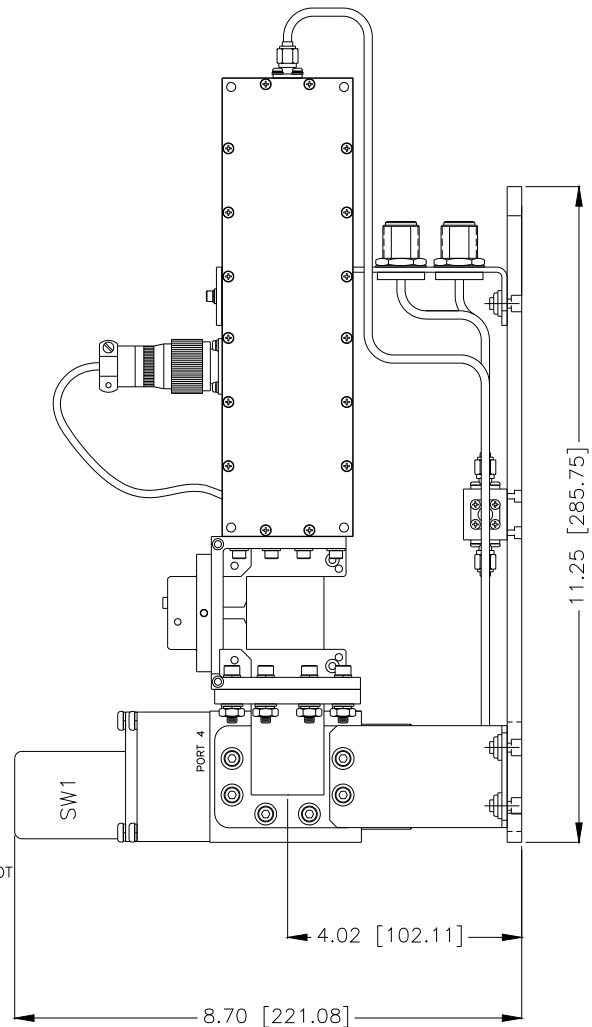
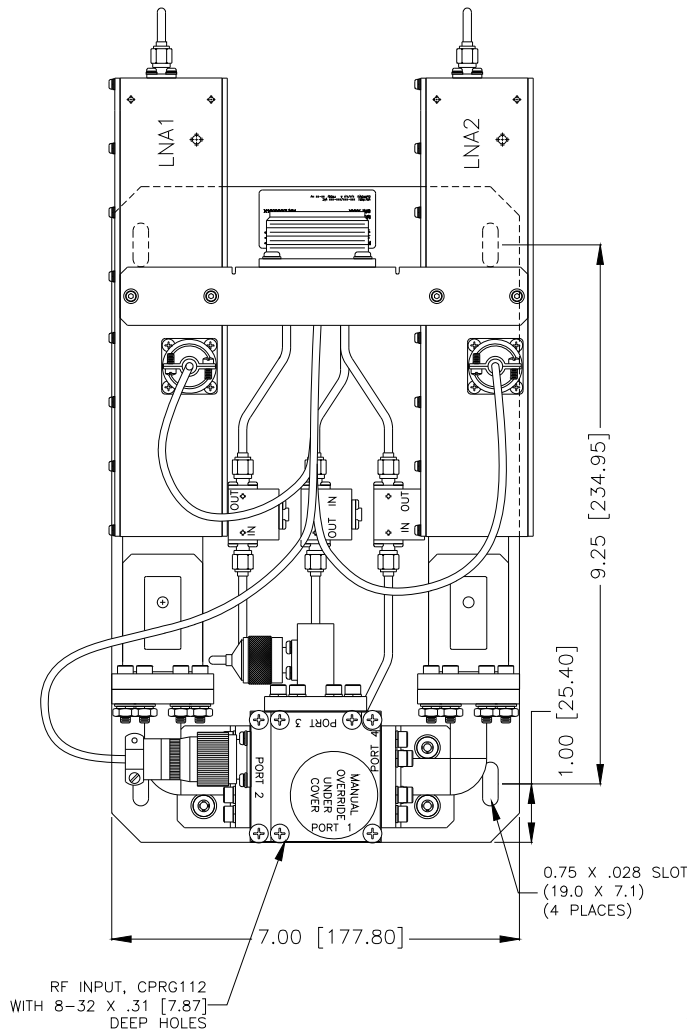
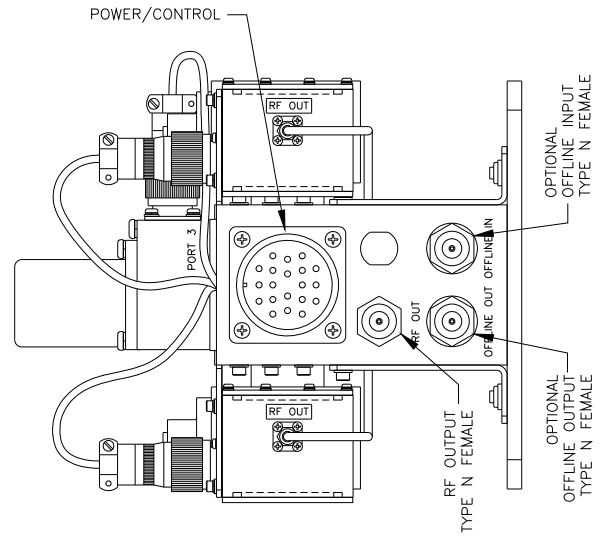

System level equipment

DESCRIPTION	QUANTITY PER SYSTEM		NOTES
	1:1	1:2	
Antenna hub-mount plate assembly	1	-	1:1 system includes 1 ea. dual waveguide-coaxial protection switch. 1:2 system includes 2 ea. dual waveguide-coaxial protection switch.
RF7 Series X-Band LNAs	2	-	Customer specified noise temperature and gain
Redundant control panel RCP-1100 (1:1) RCP-1200 (1:2)	1 -	- -	
Interface control cable	1	-	100 ft. (30 m) standard Customer specified up to 1000 ft. (300 m)
Standard test data	1 lot	-	Customer specified special testing available

System level performance

PARAMETER	SYSTEM PERFORMANCE*			WITH OPTION(S)
	1:1	1:2		
		Pol. 1	Pol. 2	
System Noise Temperature Contribution (above LNA noise temperature)	5 K 15 K 7 K 18 K	- - - -	- - - -	None Tx Filter Input Test Coupler Tx Filter & Input Test Coupler
System Noise Temp. vs, Ambient Temp. (approx.)	0.40 K/°C	-	-	Option-independent
System Gain vs. Ambient Temp. (approx.)	- 0.04 dB/°C	-	-	Option-independent
System VSWR				
Input				
on-line RF thru-paths	1.3:1	-	-	
off-line and coaxial coupled input ports	1.5:1	-	-	
Output				
all RF output ports (except cpld. out)	1.25:1	-	-	

* System level performance based on use of Paradise Datacom RF7 Series X-band low noise amplifiers (LNAs). Specifications are subject to change.



System Configurator

L	N	1	X																
---	---	---	---	--	--	--	--	--	--	--	--	--	--	--	--	--	--	--	--

Output Frequency
X - X-Band

System Configuration
1 - 1:1 Redundant
2 - 1:2 Redundant

Number of LNAs in System
0, 1, 2, or 3

LNA Frequency Band
A - 7.25 - 7.75
Z - N/A

LNA Gain
1 - 50
2 - 60
5 - Custom
9 - N/A

Special Options
XX - None
CX - 30dB Output Coupler
XM - Compatible Plate Assembly

Cables
X - No Cables
A - 100 ft. Control Cable
D - 150 ft. Control Cable
Z - Custom Control Cable Length

Offline & Test Ports
0 - None
1 - Offline
2 - 30dB Test Input
3 - Offline & 30dB Test Input
4 - 40dB Test Input
5 - Offline & 40dB Test Input

Controller
0 - None
1 - RCP2-1100
2 - RCP2-1200
4 - RCP2-1100, 48VDC
5 - RCP2-1200, 48VDC

Tx Reject Filter
0 - No
1 - Yes

LNA Noise Temperature
A - 45 C - 55 E - 65
B - 50 D - 60 F - 70
Z - N/A