

The New Standard in High Power Redundant
Microwave Amplifier Systems Has Arrived



**2.5 kW Ku-Band Solid State High Power Amplifier System
configured with (8) Modules**

FEATURES

- Gallium Nitride amplifiers, offering better power over frequency
- Output Power levels of up to:
10 kW in S-, C- and X-Bands;
5.8 kW in Ku-Band
- No Active Switching-All Passive Power Combining
- System is 100% field maintainable
- Output Power sized for N+1 Redundancy
- All active modules are hot swappable via the front or rear panels
- System can be configured with any combination of 4 to 16 modules.
- Hot Swappable Redundant Power Supply Modules
- Hot Swappable SSPA Modules
- Removable Fan Trays
- Removable M&C Card Assembly
- System monitor and control emulates single SSPA Chassis operation
- Ethernet Port with UDP, SNMP, and internal web browser capability
- Legacy RS-485 M&C
- Accurate Output Power Measurement
- Reflected Power Monitor
- RF Output Sample Port
- RF Gain Adjustment
(42 dB - 62 dB) Ku-Band systems
(50 dB - 70 dB) all others
- System is field scalable: i.e., can start out with (4) modules in system and upgrade to (8) or (16) modules.

PowerMAX is covered by U.S. Patent Nos.
8,189,338 B2 and 8,411,477 B2



System Operation

The PowerMAX system maintains complete parallel redundancy down to the embedded control level. Therefore the loss of an entire HPA chassis will not interrupt remote communications with the system. Remote communications can be either RS-485 or Ethernet. The system will automatically correct its gain level in the event of one or more HPA chassis failures.

The sophisticated system monitor and control allows the system to be locally or remotely operated as if it were a “single” chassis amplifier. The system control maintains a hierarchical management that allows the operator to interface to a single chassis of the multi-module array.

Another feature unique to Teledyne Paradise Datacom’s PowerMAX is the introduction of “true rms” output power measurement. Unlike other amplifier systems that utilize diode detection schemes, the PowerMAX reports the true rms output power of the system independent of the number of carriers and modulation schemes.

Proprietary waveguide combining techniques are employed so that maximum power combining efficiency is optimized within the operating frequency band.

System Output Power and Configurations

Because the system power combining is purely passive and no switching is used, there is never an interruption in RF output power. The PowerMAX system is typically used as a “self-redundant” system. The output power is sized such that the loss of (1) RF module’s power will still allow the system to maintain its minimum required output power. This type of system architecture is described as n+1 redundant. The system can be configured with any number of modules but best overall efficiency is obtained with the popular binary combinations of 4, 8, or 16 modules. It is very easy to upgrade the PowerMAX system from 4 modules to 8 or 16 modules in the field. It is not necessary to fully populate the system at the time of initial purchase. This provides the user a path to upgrade output power capability as system requirements grow, thus keeping capital investment minimized. For sizing redundant output power capability use the following guideline to determine the output power of the system with the loss of (1) module.

4 Module System - 3 of 4 Modules Operable = 2.5 dB loss in output power capability

8 Module System - 7 of 8 Modules Operable = 1.2 dB loss in output power capability

16 Module System - 15 of 16 Modules Operable = 0.6 dB loss in output power capability

System Prime Input Power

Proprietary adaptive bias techniques are utilized to achieve an aggressive balance between RF output power and minimized DC input power.

Prime power may be introduced into a terminal block at the top of the cabinet. Electrical conduit is routed between the terminal block and a 5RU boxed assembly, the AC Distribution/Circuit Breaker Panel, which houses a separate toggle switch circuit breaker for each power supply module in the system. Additional circuit breakers are available for auxiliary equipment mounted in the cabinet.

System prime input power is achieved with an array of modular (hot-swap) power supply chassis. Power is distributed from the power supplies to the SSPA modules via a bus rail assembly.

Each of the power supply modules has its own single phase, 180-264 VAC input. This makes it very convenient to parallel the AC inputs of two modules and connect the array to a three phase AC input source.

The power supply chassis is configured as a n+1 redundant, hot swappable power supply. In the event of a power supply module failure, the amplifier system will not fail. The failed module can be changed without ever taking the HPA out of service. The microwave amplifier architecture is also designed for maximum soft fail redundancy.

Prime system AC Input Power specifications are shown on pages 6-8 for various PowerMAX power levels and configurations.



Terminal Block

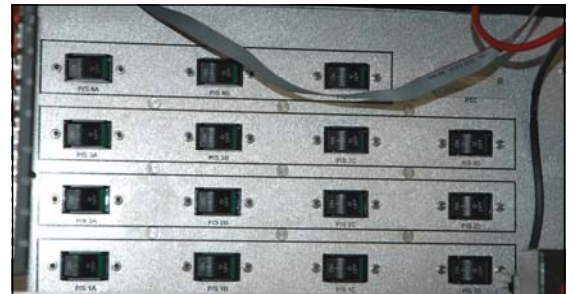

Circuit Breaker Panel



Power Supply Module in Chassis



Quick Connect Plug into Bus Rail

Hitless Redundancy

For mission critical systems in which no power outage can be tolerated, an eight module PowerMAX system can be operated with only four modules installed. In this way, the additional four modules can be installed without requiring the system to be powered off.

The only disadvantage of operating the eight module PowerMAX system with four modules is the additional 3 dB loss that the four module (half-system) system experiences by going through the final hybrid combiner as shown at right. Therefore the overall output power is actually 6 dB below what it would be with all eight modules present in the system.

If, however, the module output power is sized such that this reduction in output power can be tolerated, the system shown at right is an effective means of scaling the system from four to eight modules and maintaining true hitless operation. The system never has to be powered down and there are no mechanical switches involved that would create an interruption of service.

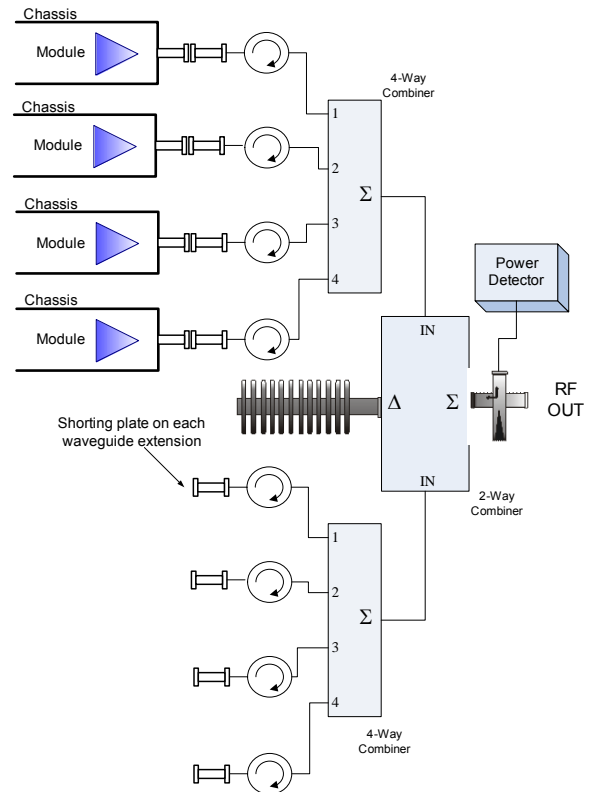

With parallel system architectures, the amplifier output power capability and gain will change as the number of active modules vary. The PowerMAX system is designed with an Auto-Gain Control mode so that the overall system gain will remain constant in the event of a single module failure. See the table below.

System Type	# Modules in System	Gain Change Auto Gain Control On	Gain Change Auto Gain Control Off	Maximum Output Power
4-Chassis	3 of 4	0 dB	-2.5 dB	-2.5 dB
4-Chassis	2 of 4	-1.0 dB	-6.0 dB	-6.0 dB
4-Chassis	1 of 4	-7.0 dB	-12.0 dB	-12.0 dB
8-Chassis	7 of 8	0 dB	-1.2 dB	-1.2 dB
8-Chassis	6 of 8	0 dB	-2.4 dB	-2.4 dB
8-Chassis	5 of 8	0 dB	-4.0 dB	-4.0 dB
8-Chassis	4 of 8	-1.0 dB	-6.0 dB	-6.0 dB
8-Chassis	3 of 8	-3.5 dB	-8.5 dB	-8.5 dB
8-Chassis	2 of 8	-7.5 dB	-12.5 dB	-12.5 dB
16-Chassis	15 of 16	0 dB	-0.6 dB	-0.6 dB
16-Chassis	14 of 16	0 dB	-1.2 dB	-1.2 dB
16-Chassis	13 of 16	0 dB	-2.0 dB	-2.0 dB
16-Chassis	12 of 16	0 dB	-2.5 dB	-2.5 dB

SSPA Chassis Population Options

The PowerMAX system is available in a variety of system GaN module configurations and output power levels. The system is based on Teledyne Paradise Datacom's 3RU chassis with 100% hot swappable active assemblies. The units can be configured with a wide variety of SSPA frequency bands and power levels, and can be fitted with the following SSPA modules:

- **S-Band:** 50W, 100W, 200W, 300W, 400W, 500W, 600W, 800W, 1 kW
- **C-Band:** 50W, 100W, 150W, 200W, 300W, 400W, 650W, 800W
- **X-Band:** 300W, 400W, 650W, 800W
- **Ku Band:** 50W, 80W, 100W, 150W, 200W, 300W, 400W, 500W

Hot-Swap Chassis Features

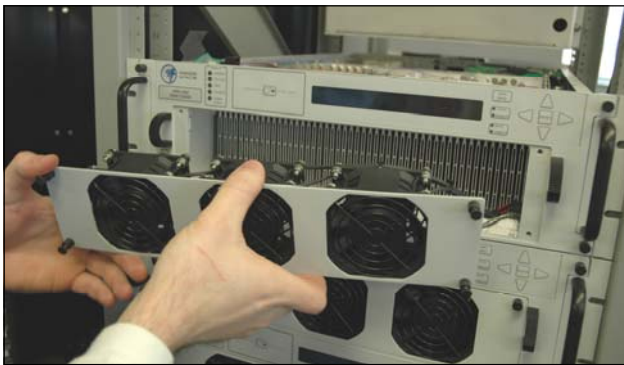

Removable front panel fan tray

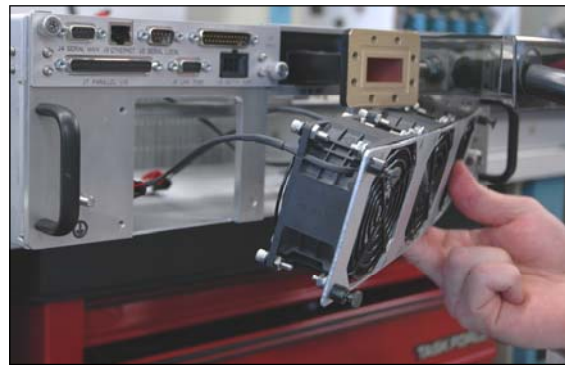

Removable rear panel fan tray



Removable rear panel monitor and control card

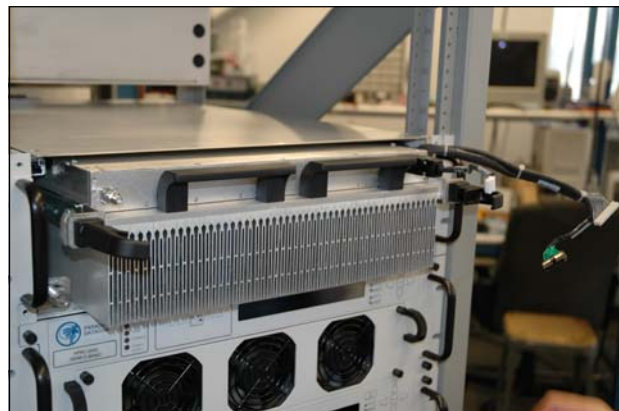

SSPA Module Removal via the front panel

4 Module S-Band PowerMAX System Power Specifications

SSPA Module Power Level	4 Module RF Output Power		AC Input Power (W)	Heat Load (Btu/hr)	3 Module Redundant RF Output Power	
	P_{sat} , typical dBm (W)	P_{Linear} , min. dBm (W)	P_{sat} / P_{Linear}	P_{sat} / P_{Linear}	P_{sat} , typical dBm (W)	P_{Linear} , min. dBm (W)
50 W	52.6 (180)	49.6 (90)	1,600/1,200	3,740/2,950	50.2 (104)	47.2 (52)
100 W	55.1 (320)	52.1 (160)	2,000/1,600	4,350/3,800	52.7 (184)	49.7 (92)
200 W	58.1 (638)	55.1 (320)	3,200/2,800	8,700/8,000	55.7 (367)	52.7 (184)
300 W	59.9 (970)	56.9 (484)	5,200/4,000	10,858/9,200	57.5 (560)	54.5 (280)
400 W	61.1 (1280)	58.1 (638)	6,400/5,200	13,000/12,000	58.7 (733)	55.7 (367)
500 W	62.1 (1600)	59.1 (803)	7,200/6,000	14,000/13,500	59.7 (923)	56.7 (462)
600 W	63.1 (2000)	60.1 (1000)	8,800/6,800	17,000/15,000	60.7 (1100)	57.7 (582)
800 W	64.1 (2570)	61.1 (1288)	10,000/8,000	18,000/17,000	61.7 (1500)	58.7 (733)
1000 W	65.1 (3200)	62.1 (1600)	16,000/14,000	32,600/31,000	62.7 (1800)	59.7 (923)

4 Module C-Band PowerMAX System Power Specifications

SSPA Module Power Level	4 Module RF Output Power		AC Input Power (W)	Heat Load (Btu/hr)	3 Module Redundant RF Output Power	
	P_{sat} , typical dBm (W)	P_{Linear} , min. dBm (W)	P_{sat} / P_{Linear}	P_{sat} / P_{Linear}	P_{sat} , typical dBm (W)	P_{Linear} , min. dBm (W)
50 W	52.5 (178)	49.5 (89)	2,000/1,600	4,900/3,800	50.1 (102)	47.0 (50)
100 W	55.5 (355)	52.5 (178)	2,400/2,000	5,440/4,350	53.1 (204)	50.1 (102)
150 W	57.3 (537)	54.3 (269)	4,000/3,200	9,233/7,057	54.9 (309)	51.9 (155)
200 W	58.5 (708)	55.5 (355)	4,400/3,520	9,797/7,404	56.0 (398)	53.0 (200)
300 W	60.0 (1000)	57.0 (501)	6,000/5,200	13,000/10,800	57.8 (603)	54.9 (302)
400 W	61.5 (1413)	58.5 (708)	7,200/6,400	15,200/13,000	59.1 (813)	56.1 (407)
650 W	63.6 (2291)	60.6 (1148)	13,200/11,200	28,800/23,400	61.2 (1318)	58.2 (661)
800 W	64.5 (2818)	61.5 (1413)	16,000/14,000	35000/29400	62.1 (1622)	59.1 (813)

**Modular N+1 Soft-Fail
Phase Combined System**

4 Module X-Band PowerMAX System Power Specifications

SSPA Module Power Level	4 Module RF Output Power		AC Input Power (W)	Heat Load (Btu/hr)	3 Module Redundant RF Output Power	
	P_{sat} , typical dBm (W)	P_{Linear} , min. dBm (W)	P_{sat} / P_{Linear}	P_{sat} / P_{Linear}	P_{sat} , typical dBm (W)	P_{Linear} , min. dBm (W)
300 W	60.2 (1047)	57.2 (525)	6,000/5,200	13,034/10,858	57.8 (603)	54.8 (302)
400 W	61.4 (1380)	58.4 (692)	8,000/6,800	17,428/14,165	59.0 (794)	56.0 (398)
650 W	63.5 (2239)	60.5 (1122)	13,200/11,200	28,879/23,439	61.1 (1288)	58.1 (646)
800 W	64.4 (2754)	61.4 (1380)	16,000/14,000	34,880/29,438	62.0 (1585)	59.0 (794)

4 Module Ku-Band PowerMAX System Power Specifications

SSPA Module Power Level	4 Module RF Output Power		AC Input Power (W)	Heat Load (Btu/hr)	3 Module Redundant RF Output Power	
	P_{sat} , typical dBm (W)	P_{Linear} , min. dBm (W)	P_{sat} / P_{Linear}	P_{sat} / P_{Linear}	P_{sat} , typical dBm (W)	P_{Linear} , min. dBm (W)
50 W	52.3 (170)	49.3 (85)	2,400/2,000	5,983/4,900	50.0 (100)	47.0 (50)
80 W	54.3 (269)	51.3 (135)	2,920/2,340	7,078/5,501	51.9 (155)	48.9 (78)
100 W	55.3 (339)	52.3 (170)	3,000/2,550	9,233/7,601	52.9 (195)	49.9 (98)
150 W	57.1 (513)	54.1 (257)	4,800/3,680	11,409/8,363	54.7 (295)	51.7 (148)
200 W	58.3 (676)	55.3 (339)	9,200/8,000	22,853/19,000	56.0 (398)	53.0 (200)
300 W	60.1 (1023)	57.1 (513)	11,000/8,400	22,600/19,600	57.7 (589)	54.7 (295)
400 W	61.3 (1350)	58.3 (676)	12,800/9,600	30,500/22,000	58.9 (776)	55.9 (389)
500 W	62.3 (1698)	59.3 (851)	16,000/12,000	38,000/27,000	60.0 (1000)	57.0 (501)

8 Module S-Band PowerMAX System Power Specifications

SSPA Module Power Level	8 Module RF Output Power		AC Input Power (W)	Heat Load (Btu/hr)	7 Module Redundant RF Output Power	
	P_{sat} , typical dBm (W)	P_{Linear} , min. dBm (W)	P_{sat} / P_{Linear}	P_{sat} / P_{Linear}	P_{sat} , typical dBm (W)	P_{Linear} , min. dBm (W)
50 W	55.0 (316)	52.0 (158)	3,200/2,400	7,480/5,900	53.8 (240)	50.8 (120)
100 W	57.5 (562)	54.5 (282)	4,000/3,200	8,700/7,600	56.3 (427)	53.3 (214)
200 W	60.5 (1100)	57.5 (562)	6,400/5,600	18,000/17,000	59.3 (851)	56.3 (427)
300 W	62.3 (1700)	59.3 (851)	10,400/8,000	21,700/18,400	61.1 (1300)	58.1 (646)
400 W	63.5 (2240)	60.5 (1100)	12,800/10,400	26,153/23,957	62.3 (1700)	59.3 (851)
500 W	64.5 (2800)	61.5 (1400)	14,400/12,000	31,552/28,800	63.3 (2100)	60.3 (1100)
600 W	65.5 (3500)	62.5 (1800)	17,600/13,600	34,142/30,000	64.3 (2700)	61.3 (1350)
800 W	66.5 (4500)	63.5 (2240)	20,000/16,000	37,100/34,800	65.3 (3400)	62.3 (1700)
1000 W	67.5 (5600)	64.5 (2800)	32,000/28,000	65,280/65,000	66.3 (4300)	63.3 (2100)

8 Module C-Band PowerMAX System Power Specifications

SSPA Module Power Level	8 Module RF Output Power		AC Input Power (W)	Heat Load (Btu/hr)	7 Module Redundant RF Output Power	
	P_{sat} , typical dBm (W)	P_{Linear} , min. dBm (W)	P_{sat} / P_{Linear}	P_{sat} / P_{Linear}	P_{sat} , typical dBm (W)	P_{Linear} , min. dBm (W)
50 W	55.0 (316)	52.0 (158)	4,000/3,200	9,790/7,613	53.8 (240)	50.8 (120)
100 W	58.3 (676)	55.3 (339)	4,200/3,500	9,520/8,500	57.1 (513)	54.1 (257)
150 W	60.0 (1000)	57.0 (501)	8,000/6,400	18,466/14,114	58.8 (759)	55.8 (380)
200 W	61.5 (1413)	58.5 (708)	8,800/7,040	19,590/14,807	60.3 (1072)	57.3 (537)
300 W	63.0 (1995)	60.0 (1000)	12,000/10,400	26,000/21,700	61.9 (1549)	58.9 (776)
400 W	64.3 (2692)	61.3 (1349)	14,400/12,800	30,500/26,153	63.1 (2042)	60.1 (1023)
650 W	66.4 (4365)	63.4 (2188)	26,400/22,400	57,750/46,880	65.2 (3311)	62.2 (1660)
800 W	67.3 (5370)	64.3 (2692)	32,000/28,000	69,755/58,875	66.1 (4074)	63.1 (2042)

8 Module X-Band PowerMAX System Power Specifications

SSPA Module Power Level	8 Module RF Output Power		AC Input Power (W)	Heat Load (Btu/hr)	7 Module Redundant RF Output Power	
	P_{sat} , typical dBm (W)	P_{Linear} , min. dBm (W)	P_{sat} / P_{Linear}	P_{sat} / P_{Linear}	P_{sat} , typical dBm (W)	P_{Linear} , min. dBm (W)
300 W	63.0 (1995)	60.0 (1000)	12,000/10,400	26,000/21,717	61.8 (1514)	58.8 (759)
400 W	64.2 (2630)	61.2 (1318)	16,000/13,600	34,857/28,329	63.0 (1995)	60.0 (1000)
650 W	66.3 (4266)	63.3 (2138)	26,400/22,400	57,759/46,879	65.1 (3236)	62.1 (1622)
800 W	67.2 (5248)	64.2 (2630)	32,000/28,000	69,755/58,875	66.0 (3981)	63.0 (1995)

8 Module Ku-Band PowerMAX System Power Specifications

SSPA Module Power Level	8 Module RF Output Power		AC Input Power (W)	Heat Load (Btu/hr)	7 Module Redundant RF Output Power	
	P_{sat} , typical dBm (W)	P_{Linear} , min. dBm (W)	P_{sat} / P_{Linear}	P_{sat} / P_{Linear}	P_{sat} , typical dBm (W)	P_{Linear} , min. dBm (W)
50 W	55.0 (316)	52.0 (158)	4,800/4,000	12,000/9,800	53.8 (240)	50.8 (120)
80 W	57.0 (501)	54.0 (251)	5,840/4,680	14,156/11,000	55.8 (380)	52.8 (191)
100 W	58.0 (631)	55.0 (316)	8,000/6,800	19,500/16,300	56.8 (479)	53.8 (240)
150 W	59.8 (955)	56.8 (479)	9,600/7,200	22,818/16,290	58.6 (724)	55.6 (363)
200 W	61.0 (1259)	58.0 (631)	18,400/16,000	45,706/37,500	59.8 (955)	56.8 (479)
300 W	62.8 (1905)	59.8 (955)	22,000/16,800	53,300/39,100	61.6 (1445)	58.6 (724)
400 W	64.0 (2512)	61.0 (1259)	25,600/19,200	61,000/43,560	62.8 (1905)	59.8 (955)
500 W	65.0 (3162)	62.0 (1585)	32,000/24,000	76,100/54,300	63.8 (2399)	60.8 (1202)

16 Module S-Band PowerMAX System Power Specifications

SSPA Module Power Level	16 Module RF Output Power		AC Input Power (W)	Heat Load (Btu/hr)	15 Module Redundant RF Output Power	
	P_{sat} , typical dBm (W)	P_{Linear} , min. dBm (W)	P_{sat} / P_{Linear}	P_{sat} / P_{Linear}	P_{sat} , typical dBm (W)	P_{Linear} , min. dBm (W)
50 W	57.5 (556)	54.5 (279)	6,400/4,800	14,960/11,800	56.9 (484)	53.9 (243)
100 W	60.0 (1000)	57.0 (500)	8,000/6,400	17,400/15,200	59.4 (861)	56.4 (432)
200 W	63.0 (2000)	60.0 (1000)	12,800/11,200	36,000/34,600	62.4 (1700)	59.4 (861)
300 W	64.8 (3000)	61.8 (1500)	20,800/16,000	43,433/36,949	64.2 (2600)	61.2 (1300)
400 W	66.0 (4000)	63.0 (2000)	25,600/20,800	52,300/47,900	65.4 (3400)	62.4 (1700)
500 W	67.0 (5000)	64.0 (2500)	28,800/24,000	56,500/54,000	66.4 (4300)	63.4 (2100)
600 W	68.0 (6300)	65.0 (3100)	35,200/27,200	68,285/60,254	67.4 (5400)	64.4 (2700)
800 W	69.0 (7800)	66.0 (4000)	40,000/32,000	74,200/69,750	68.4 (6800)	65.4 (3400)
1000 W	70.0 (10000)	67.0 (5000)	64,000/56,000	130,000/129,000	69.4 (8600)	66.4 (4300)

16 Module C-Band PowerMAX System Power Specifications

SSPA Module Power Level	16 Module RF Output Power		AC Input Power (W)	Heat Load (Btu/hr)	15 Module Redundant RF Output Power	
	P_{sat} , typical dBm (W)	P_{Linear} , min. dBm (W)	P_{sat} / P_{Linear}	P_{sat} / P_{Linear}	P_{sat} , typical dBm (W)	P_{Linear} , min. dBm (W)
50 W	58.0 (631)	55.0 (316)	8,000/6,400	20,000/15,000	57.2 (525)	54.2 (263)
100 W	61.0 (1259)	58.0 (631)	9,600/8,000	21,760/17,408	60.4 (1096)	57.4 (550)
150 W	62.8 (1905)	59.8 (955)	16,000/12,800	37,000/28,000	62.2 (1660)	59.2 (832)
200 W	64.0 (2512)	61.0 (1259)	17,600/14,080	39,189/29,614	63.4 (2188)	60.4 (1096)
300 W	65.8 (3802)	62.8 (1905)	24,000/20,800	52,000/43,400	65.2 (3311)	62.2 (1660)
400 W	67.0 (5012)	64.0 (2512)	28,800/25,600	61,000/52,300	66.4 (4365)	63.4 (2188)
650 W	69.1 (8128)	66.1 (4074)	52,800/44,800	115,517/93,757	68.5 (7079)	65.5 (3548)
800 W	70.0 (10000)	67.0 (5012)	64,000/56,000	139,511/117,751	69.4 (8710)	66.4 (4365)

16 Module X-Band PowerMAX System Power Specifications

SSPA Module Power Level	16 Module RF Output Power		AC Input Power (W)	Heat Load (Btu/hr)	15 Module Redundant RF Output Power	
	P_{sat} , typical dBm (W)	P_{Linear} , min. dBm (W)	P_{sat} / P_{Linear}	P_{sat} / P_{Linear}	P_{sat} , typical dBm (W)	P_{Linear} , min. dBm (W)
300 W	65.6 (3631)	62.6 (1820)	24,000/20,800	52,137/43,433	65.0 (3162)	62.0 (1585)
400 W	66.9 (4898)	63.9 (2455)	32,000/27,200	69,714/56,658	66.3 (4266)	63.3 (2138)
650 W	69.0 (7643)	66.0 (3981)	52,800/44,800	115,517/93,757	68.4 (6918)	65.4 (3467)
800 W	70.0 (10000)	67.0 (5012)	64,000/56,000	139,511/117,751	69.3 (8511)	66.3 (4266)

16 Module Ku-Band PowerMAX System Power Specifications

SSPA Module Power Level	16 Module RF Output Power		AC Input Power (W)	Heat Load (Btu/hr)	15 Module Redundant RF Output Power	
	P_{sat} , typical dBm (W)	P_{Linear} , min. dBm (W)	P_{sat} / P_{Linear}	P_{sat} / P_{Linear}	P_{sat} , typical dBm (W)	P_{Linear} , min. dBm (W)
50 W	57.6 (575)	54.6 (288)	9,600/8,000	24,000/19,600	57.0 (501)	54.0 (251)
80 W	59.6 (912)	56.6 (457)	11,680/9,360	28,313/22,000	59.0 (794)	56.0 (398)
100 W	60.6 (1148)	57.6 (575)	16,000/13,600	39,168/32,640	60.0 (1000)	57.0 (501)
150 W	62.4 (1738)	59.4 (871)	19,200/14,400	45,631/32,581	61.8 (1514)	58.8 (759)
200 W	63.6 (2291)	60.6 (1148)	36,800/32,000	91,413/75,000	63.0 (1995)	60.0 (1000)
300 W	65.4 (3467)	62.4 (1738)	44,000/33,600	106,500/78,500	64.8 (3020)	61.8 (1514)
400 W	66.6 (4571)	63.6 (2291)	51,200/38,400	122,000/87,000	66.0 (3981)	63.0 (1995)
500 W	67.6 (5754)	64.6 (2884)	64,000/48,000	152,300/108,750	67.0 (5012)	64.0 (2512)

General Electrical Specifications

PARAMETER	NOTES	LIMITS	UNITS
Gain	Maximum, Ku-Band (Auto-Gain Off)	62	dB
	Maximum, Ku-Band (Auto-Gain On)	57	dB
	Maximum, S-, C-, X-Bands (Auto-Gain Off)	70	dB
	Maximum, S-, C-, X-Bands (Auto-Gain On)	65	dB
Gain Flatness	full band	± 1.0	dB
Gain Slope	per 40 MHz	± 0.3	dB/40 MHz
	per 10 MHz (S-Band)	± 0.3	dB/10 MHz
Gain Variation vs. Temperature	0 °C to +50 °C	± 1.0	dB
Gain Adjustment	0.1 dB resolution	20	dB
Intermodulation Distortion	3 dB back off relative to P _{sat}	-25	dBc
AM/PM Conversion	(@ P _{Linear})	3.5	°/dB
	(@ P _{Linear})	1.0	°/dB
Spurious Harmonics	(@ P _{Linear})	-65	dBc
	(@ P _{Linear})	-50	dBc
Input VSWR		≤ 1.30 : 1	
Output VSWR		≤ 2.00 : 1	
Noise Figure	at maximum gain	12	dB
Group Delay	Linear	0.01	ns/MHz
	Parabolic	0.003	ns/MHz ²
	Ripple	1.0	ns p-p
Noise Output	TX Band	-75	dBW/4 KHz
	RX Band (C-Band, without filter)	-155	dBW/4 KHz
	RX Band (X-Band, without filter)	-85	dBW/4 KHz
	RX Band (X-Band, with filter)	-155	dBW/4 KHz
	RX Band (Ku-Band, without filter)	-85	dBW/4 KHz
	RX Band (Ku-Band, with filter)	-155	dBW/4 KHz
Residual AM Noise	0 - 10 KHz	-45	dBc
	10 KHz - 500 KHz	-20 (1.25 + log F)	dBc
	500 KHz - 1 MHz	-80	dBc
Residual Phase Noise	Offset frequency from carrier		
	10 Hz	-90	dBc/Hz
	100 Hz	-100	dBc/Hz
	1 KHz	-110	dBc/Hz
	10 KHz	-120	dBc/Hz
	100 KHz	-125	dBc/Hz
1 MHz	-130	dBc/Hz	
RF Leakage	@ 1m, with SSPA module removed	< 0.001	mW/cm ²

Environmental Specifications

Operating Temperature	Ambient	0 to +50	°C
Relative Humidity	non-condensing	95	%
Cooling System	Integrated, forced air, per chassis	137	CFM
Audible Noise ¹	per chassis, measured 1m from unit	71	dBA

¹ Audible noise is measured with the fans set at low. Add 3 dBA to the system audible noise figure (low fan) if using the cabinet exhaust option.

System Outline Drawing

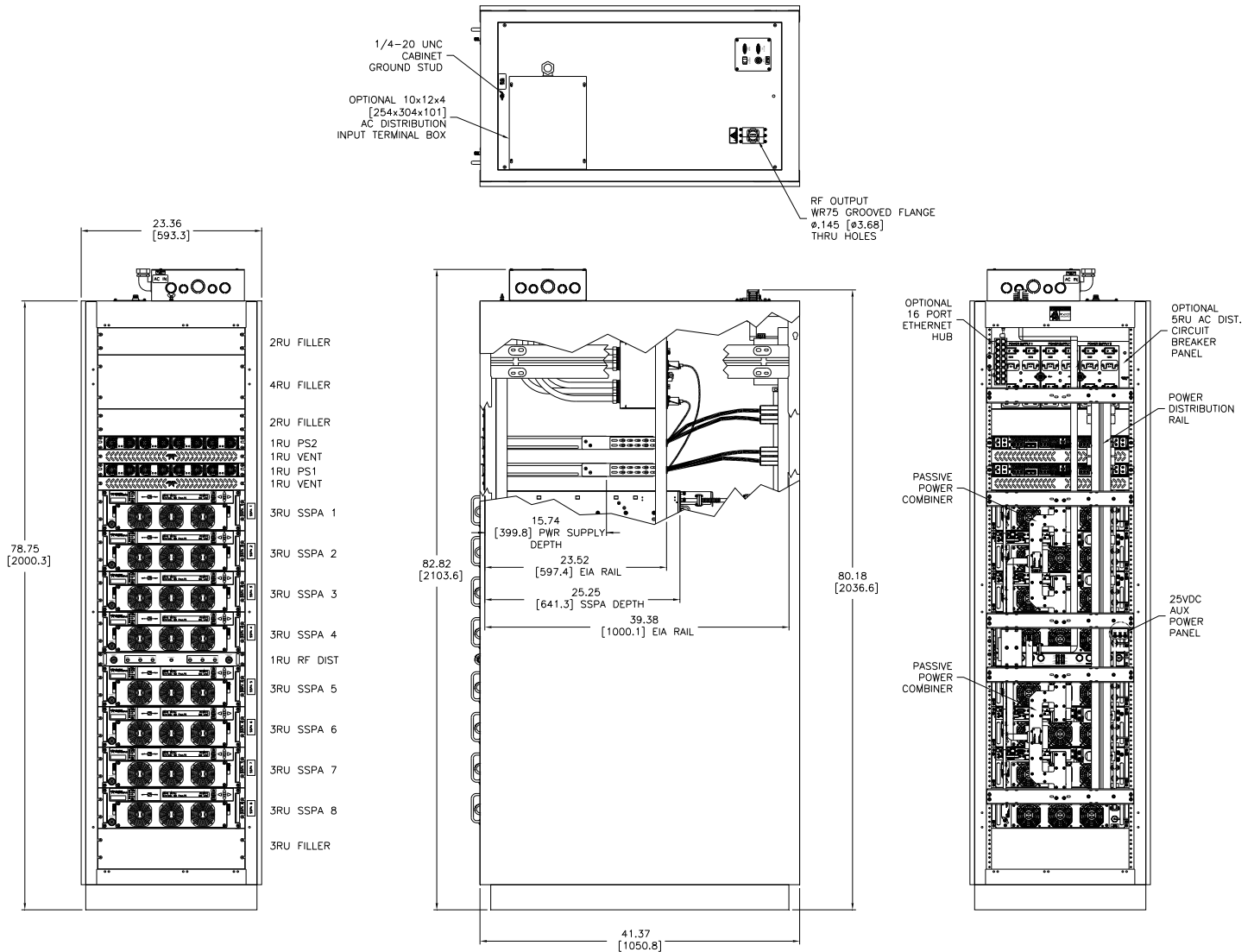

The system pictured above is typical for a 1.8 kW 8-Module Ku-Band system.

Note that certain power levels require a different power supply configuration. Consult with the factory for details on your system's prime power requirements.

Cabinet Exhaust Option

The PowerMAX system is available with an optional cabinet exhaust system, which includes a rear door for the cabinet and an impeller assembly for each grouping of four (4) SSPA chassis in the system.

Power is provided from the AC Distribution Box to the circuit-interruptible power connectors in the interior of the rear door. Separate power cables connect from the outer door couplers to each impeller.

Outline Drawing, Cabinet Exhaust Option

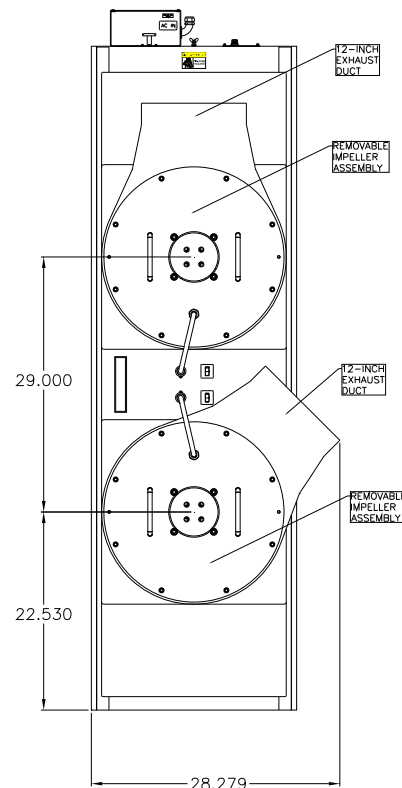
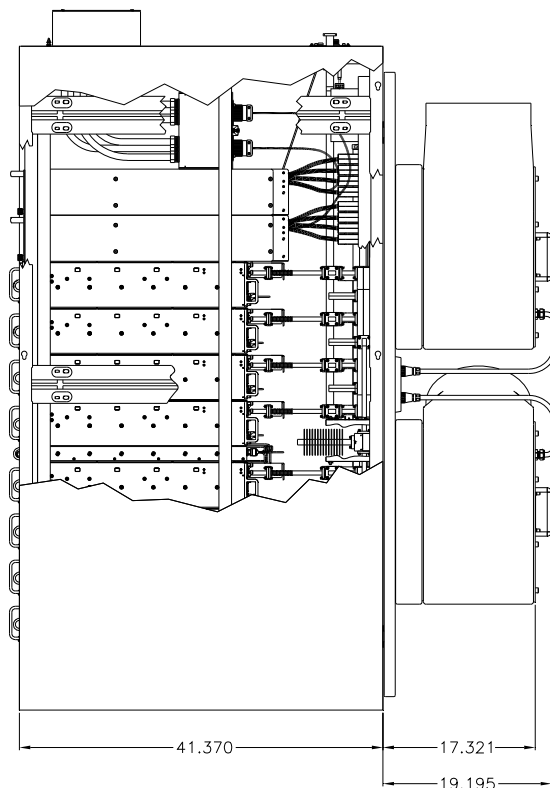
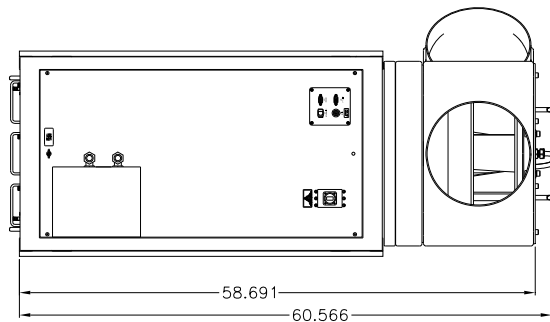

GaN PowerMAX

Modular N+1 Soft-Fail Phase Combined System

System Part Number Configuration

